

| CKT. SIZE | OPTION A (WITHOUT RIBS) | | OPTION B (WITH RIBS) | | DIMENSION | |
|-----------|-------------------------|------------|----------------------|------------|------------------|------------------|
| | EDP. NO. | ENG. NO. | EDP. NO. | ENG. NO. | A | B |
| | 4 | NOT TOOLED | X-70013-0008 | NOT TOOLED | X-70013-1004 | (5.33) .210 |
| 6 | 015-04-5061 | 70013-0001 | 015-04-5064 | 70013-1006 | (7.87) .310 | (5.08) .200 |
| 8 | 015-04-5081 | 70013-0007 | 015-04-5084 | 70013-1008 | (10.41) .410 | (7.62) .300 |
| 10 | 015-04-5101 | 70013-0002 | 015-04-5104 | 70013-1010 | (12.95) .510 | (10.16) .400 |
| 12 | 015-04-5121 | 70013-0012 | 015-04-5124 | 70013-1012 | (15.49) .610 | (12.70) .500 |
| 14 | 015-04-5141 | 70013-0014 | 015-04-5144 | 70013-1014 | (18.03) .710 | (15.24) .600 |
| 16 | 015-04-5161 | 70013-0016 | 015-04-5164 | 70013-1016 | (20.57) .810 | (17.78) .700 |
| 18 | 015-04-5181 | 70013-0018 | 015-04-5184 | 70013-1018 | (23.11) .910 | (20.32) .800 |
| 20 | 015-04-5201 | 70013-0003 | 015-04-5204 | 70013-1020 | (25.65) 1.010 | (22.86) .900 |
| 22 | 015-04-5221 | 70013-0022 | 015-04-5224 | 70013-1022 | (28.19) 1.110 | (25.40) 1.000 |
| 24 | 015-04-5241 | 70013-0024 | 015-04-5244 | 70013-1024 | (30.73) 1.210 | (27.94) 1.100 |
| 26 | 015-04-5261 | 70013-0026 | 015-04-5264 | 70013-1026 | (33.27) 1.310 | (30.48) 1.200 |
| 28 | 015-04-5281 | 70013-0028 | 015-04-5284 | 70013-1028 | (35.81) 1.410 | (33.02) 1.300 |
| 30 | 015-04-5301 | 70013-0004 | 015-04-5304 | 70013-1030 | (38.35) 1.510 | (35.56) 1.400 |
| 32 | 015-04-5321 | 70013-0032 | 015-04-5324 | 70013-1032 | (40.89) 1.610 | (38.10) 1.500 |
| 34 | 015-04-5341 | 70013-0034 | 015-04-5344 | 70013-1034 | (43.43) 1.710 | (40.64) 1.600 |
| 36 | 015-04-5361 | 70013-0036 | 015-04-5364 | 70013-1036 | (45.97) 1.810 | (43.18) 1.700 |
| 38 | 015-04-5381 | 70013-0038 | 015-04-5384 | 70013-1038 | (48.51) 1.910 | (45.72) 1.800 |
| 40 | 015-04-5401 | 70013-0005 | 015-04-5404 | 70013-1040 | (51.05) 2.010 | (48.26) 1.900 |
| 42 | 015-04-5421 | 70013-0042 | 015-04-5424 | 70013-1042 | (53.59) 2.110 | (50.80) 2.000 |
| 44 | 015-04-5441 | 70013-0044 | 015-04-5444 | 70013-1044 | (56.13) 2.210 | (53.34) 2.100 |
| 46 | 015-04-5461 | 70013-0046 | 015-04-5464 | 70013-1046 | (58.67) 2.310 | (55.88) 2.200 |
| 48 | 015-04-5481 | 70013-0048 | 015-04-5484 | 70013-1048 | (61.21) 2.410 | (58.42) 2.300 |
| 50 | 015-04-5501 | 70013-0006 | 015-04-5504 | 70013-1050 | (63.75) 2.510 | (60.96) 2.400 |

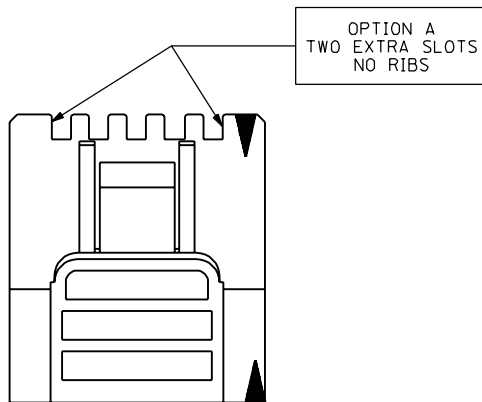
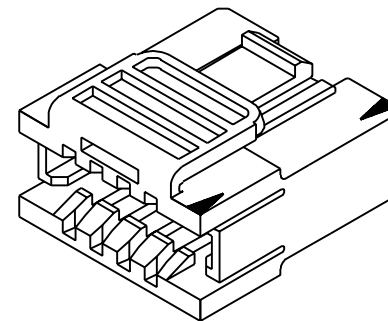
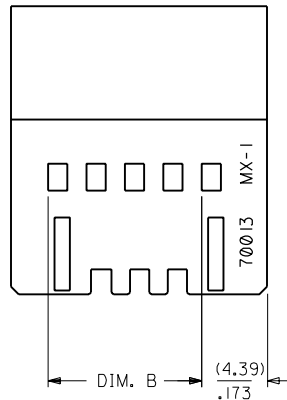
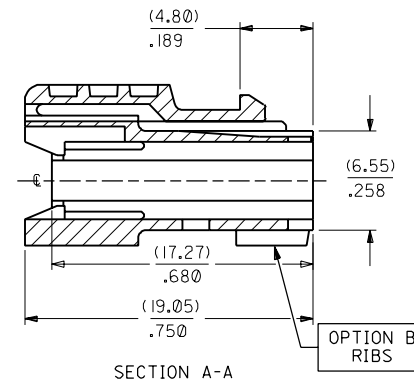
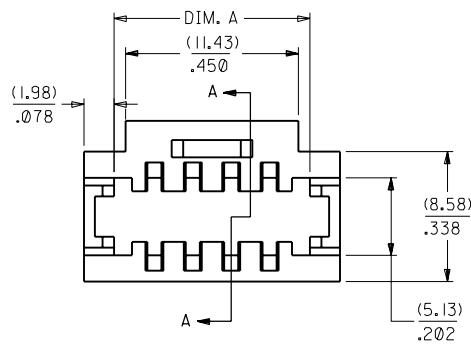
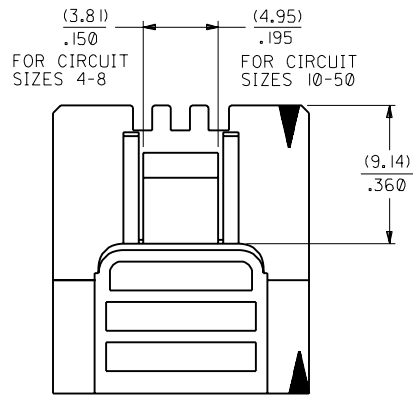

NOTES:

- 1) MATERIAL: GLASS FILLED POLYESTER, 94V-0, BLACK
- 2) MOLD TO BE EXPANDABLE FOR CIRCUIT SIZES LISTED ON CHART.
- 3) 10 CIRCUIT, B OPTION PART SHOWN.
- 4) OPTION "A" - MATES WITH HEADERS 8723-B, 8723-C, 8724-B, 8724-C, 70227, 70229, AND 70022. OPTION "B" - MATES WITH HEADERS 8723-C, 8724-C, 70227, 700229, AND 70022 (EXCEPT THE 50 CIRCUIT PARTS LISTED ON PAGE 4. SEE THE CHART ON PAGE 4 FOR MATING INTERIM CLIPS)
- 5) ALL DIMENSIONS FOR REFERENCE ONLY.
- 6) OPTIONAL SPRING CLIP FOR GREATER RETENTION OF MODULES IS RECOMMENDED FOR CIRCUIT SIZES 18-50. PART NUMBER 71809.
- 7) PACKAGE PER PK-70013-100.

| | | | | | | |
|------|--|------|---|---|--|---------------------------|
| M | ADD PKG NOTE ECN UDT2000-0468 SCHAFFER 99/12/1 | LI | REVISE PER ECR #U80583 10/10/97 HPA | DIMENSIONS SHOWN (METRIC) INCH UNLESS OTHERWISE SPECIFIED TOLERANCES: ANGULAR ± 1/2° | ▽ = 0 ▼ = 0 | REVISE ONLY ON CAD SYSTEM |
| L3 | CLEAN UP DWG PER UDT1999-0522 99/01/05 KAS | L | REVISE PER ECR #U80062 3/1/88 MJM | INCH METRIC 5 PLACE ± .010 --- 2 PLACE ± .015 ± 0.25 1 PLACE --- ± 0.38 | TITLE DUAL ROW INTERIM CLIP .100 GRID | |
| L2 | REVISE PER ECR #UDT1998-0206 98/01/09 HPA | K | REVISE TOP WALL & ANTI-FISH HOOK RIBS PER ECR#9622 1/17/87 MJM/JAS | DRAFT WHERE APPLICABLE MUST REMAIN WITHIN DIMENSIONS | SHEET NO. DATE 1 OF 4 06/23/86 | |
| LTR. | REVISIONS | LTR. | REVISIONS | DRWG. NO. BY: DJB CHK'D BY: DB APP'D BY: WZ SCALE: 4:1 | PART NO. DRWG. NO. SEE CHART SD-70013-0001-1050 | |
| | | | | THIS DRAWING CONTAINS INFORMATION THAT IS PROPRIETARY TO MOLEX INC. AND SHOULD NOT BE USED WITHOUT WRITTEN PERMISSION. | | |

| | |
|---------------|----|
| 4 | L2 |
| 3 | L1 |
| 2 | L3 |
| 1 | M |
| MFG. SH. REV. | |

4 CKT.

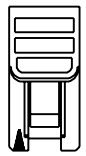

6 CKT.
3 CKT. DUAL
ROW - ODD

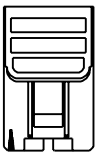

8 CKT.
4 CKT. DUAL
ROW - EVEN

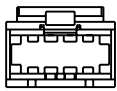
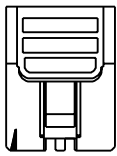

10 CKT.
SHOWN
ON SHT. 1

12 CKT.
6 CKT. DUAL
ROW - EVEN

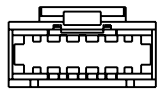
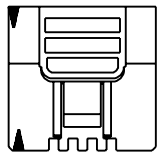

14 CKT.
7 CKT. DUAL
ROW - ODD

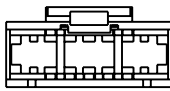
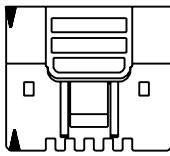

16 CKT.
8 CKT. DUAL
ROW - EVEN

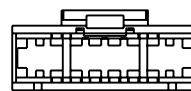
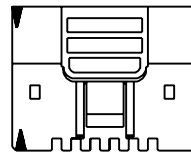

18 CKT.
9 CKT. DUAL
ROW - ODD

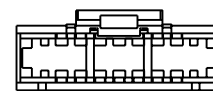
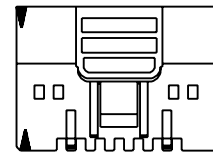

20 CKT.
10 CKT. DUAL
ROW - EVEN

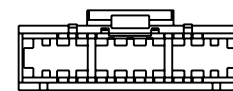
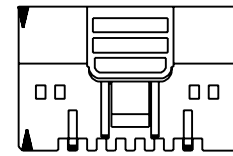

22 CKT.
11 CKT. DUAL
ROW - ODD

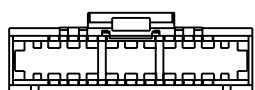
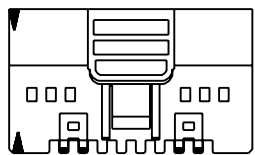

24 CKT.
12 CKT. DUAL
ROW - EVEN

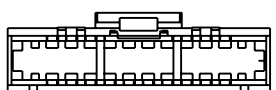
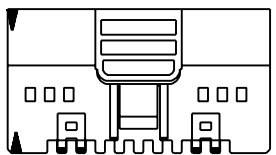

26 CKT.
13 CKT. DUAL
ROW - ODD

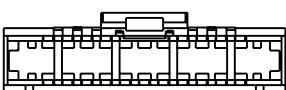
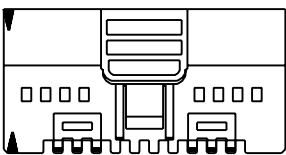

28 CKT.
14 CKT. DUAL
ROW - EVEN

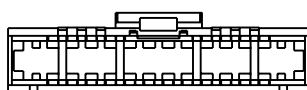
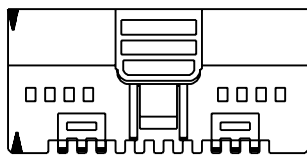

30 CKT.
15 CKT. DUAL
ROW - ODD

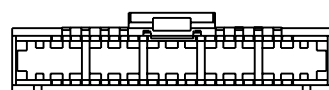
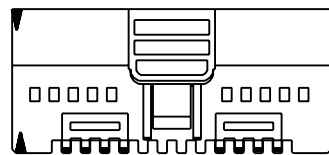

32 CKT.
16 CKT. DUAL
ROW - EVEN

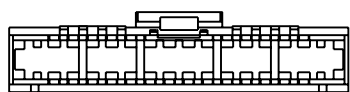
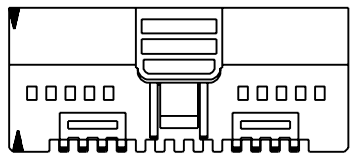

34 CKT.
17 CKT. DUAL
ROW - ODD

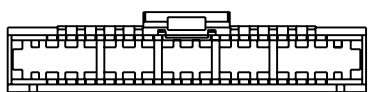
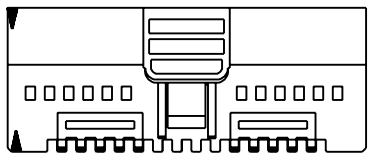

36 CKT.
18 CKT. DUAL
ROW - EVEN

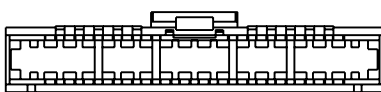
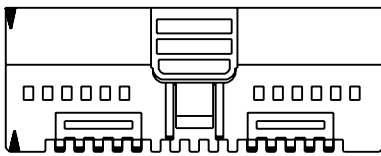

| | |
|----|-------------|
| L3 | SEE SHEET 1 |
| L | SEE SHEET 1 |
| L | SEE SHEET 1 |
| K | SEE SHEET 1 |
| J | SEE SHEET 1 |

| | | | | | | | |
|--|-----|--------------|-----|-----------------------------|-----|------------------------------|--|
| DIMENSIONS SHOWN (METRIC) INCH | | ▽ = 0 | | ◻ = 0 | | REVISE ONLY ON CAD SYSTEM | |
| UNLESS OTHERWISE SPECIFIED TOLERANCES ANGULAR ± 1/2° | | | | | | | |
| | | INCH | | METRIC | | | |
| 3 PLACE | ± | 0.10 | --- | --- | --- | | |
| 2 PLACE | ± | 0.15 | ± | 0.25 | --- | | |
| 1 PLACE | --- | --- | ± | 0.38 | --- | | |
| DRAWING WHERE APPLICABLE MUST REMAIN WITHIN DIMENSIONS | | | | | | | |
| DRAWN BY: DJB | | CHK'D BY: DB | | PART NO. SD-70013-0001-1050 | | DRWG. NO. SD-70013-0001-1050 | |
| APP'D BY: WZ | | SCALE: 2:1 | | FILE NAME: S70013X2.DWG | | DATE: 06/25/86 | |
| SEE CHART | | | | MOLEX INCORPORATED U.S.A. | | | |
| THIS DRAWING CONTAINS INFORMATION THAT IS PROPRIETARY TO MOLEX INC. AND SHOULD NOT BE USED WITHOUT WRITTEN PERMISSION. | | | | DIV. DP | | | |